

## APPROXIMATION HARDNESS OF GRAPHIC TSP ON CUBIC GRAPHS

MAREK KARPINSKI<sup>1</sup> AND RICHARD SCHMIED<sup>2</sup>

**Abstract.** We prove explicit approximation hardness results for the Graphic TSP on cubic and subcubic graphs as well as the new inapproximability bounds for the corresponding instances of the (1,2)-TSP. The result on the Graphic TSP for cubic graphs is the first known inapproximability result on that problem. The proof technique in this paper uses new modular constructions of simulating gadgets for the restricted cubic and subcubic instances. The modular constructions used in the paper could be also of independent interest.

**Keywords.** Traveling Salesman Problem, Approximability.

**Mathematics Subject Classification.** 68W25, 68W40.

### 1. INTRODUCTION

We study the Traveling Salesman Problem in the shortest path metric completion (*Graphic TSP*) of cubic as well as subcubic graphs. These two cases played a crucial role in some recent developments on *Graphic TSP* (cf. [4, 5, 10, 16, 17]). We shed some light on their inapproximability status and prove explicit approximation hardness bounds of 1153/1152 for the cubic *Graphic TSP* and 685/684 for the subcubic case. The result on the *Graphic TSP* for cubic graphs is the first inapproximability result known on that problem (cf. [4, 5]). For the most recent

---

Received March 19, 2014. Accepted December 8, 2014.

<sup>1</sup> Departement of Computer Science and the Hausdorff Center for Mathematics, University of Bonn. Supported in part by DFG Grants and the Hausdorff Grant EXC59-1/2. [marek@cs.uni-bonn.de](mailto:marek@cs.uni-bonn.de)

<sup>2</sup> Departement of Computer Science, University of Bonn. Work supported by Hausdorff Doctoral Fellowship. [schmied@cs.uni-bonn.de](mailto:schmied@cs.uni-bonn.de)

improvements on the explicit inapproximability bounds on the general metric TSP see [13].

We design new 3-regular gadget amplifier construction yielding the above bounds, and establish also new inapproximability bounds for the cubic and subcubic instances of the (1,2)-TSP of 1141/1140 and 673/672, respectively.

The inapproximability bounds for the (1,2)-TSP improve over the bounds of 1291/1290 and 787/786 claimed in [7] (see also [9]). Our proof method in this paper depends on improved amplifier construction and two transparent and direct reduction stages, firstly proving approximation lower bounds for the cubic and subcubic instances of the (1,2)-TSP, and then connecting it, in a special way, to the cubic and subcubic instances of the Graphic TSP.

We call an instance of (1,2)-TSP cubic and subcubic if the graph induced by the all weight 1 edges is cubic and subcubic, respectively.

## 2. ORGANIZATION OF THE PAPER

The paper is organized as follows. In Section 3, we give some basic definitions. In Section 4, we review some connections between the approximability of the Graphic TSP and the (1,2)-TSP. In Section 5, we formulate our main results, whereas in Section 6, we describe the techniques used in our proofs. In Section 7, we introduce a bounded occurrence Constraint Satisfaction problem called the Hybrid problem. In Section 8, we describe the reduction given in [15] from the Hybrid problem to the (1,2)-TSP. In Sections 9 and 10, we introduce modular gadget constructions and prove explicit approximation hardness bounds for the (1,2)-TSP in subcubic and cubic graphs, respectively. The inapproximability results for the Graphic TSP in cubic and subcubic graphs are given in Section 11. In Section 12, we summarize our results.

## 3. PRELIMINARIES

Given an arbitrary connected undirected graph  $G = (V, E)$ , we consider the shortest path metric completion  $G'$  and define the Graphic TSP problem for  $G$  as the standard TSP on the metric instance  $G'$ . Equivalently, the Graphic TSP is the problem of finding a smallest Eulerian spanning multi-subgraph of  $G$ . We are interested here in special cases of the above problem for cubic (3-regular) and subcubic (maximum degree 3). Both cases are known to be **NP**-hard in exact setting, as the Hamiltonian cycle problem is **NP**-hard for the 3-regular graphs (*cf.* [11]), it can be reduced to both (1,2)-TSP and Graphic TSP on cubic graphs.

In order to describe a (1,2)-TSP instance, it is sufficient to specify the edges of weight one. By constructing a graph  $G = (V, E)$ , the distance of the vertices  $u$  and  $v$  is defined to be 1 if  $\{u, v\} \in E$  and 2 otherwise. To compute the cost of a tour, it is enough to consider the parts of the tour traversing edges of  $G$ . We call a vertex, in which the tour leaves or enters  $G$  an *endpoint*. In addition, a vertex with the property that the tour both enters and leaves  $G$  in that vertex is called

*double endpoint*, and we count it as two endpoints. If  $n$  is the number of vertices and  $2 \cdot p$  is the total number of endpoints, the cost of the tour is  $n + p$  since every edge of weight two corresponds to two endpoints. On the other hand, every tour with cost  $n + p$  has exactly  $2 \cdot p$  endpoints.

#### 4. APPROXIMABILITY

The Graphic TSP for cubic and subcubic graphs is of special interest because of its connection to the famous  $4/3$  conjecture on the integrality gap of the metric TSP (cf. [4, 5]). Recently, the first polynomial time approximation algorithms with approximation factor  $4/3$  for the above problem on cubic and subcubic graphs were designed [5, 16]. This was slightly improved beyond  $4/3$  bound for the case of 2-connected cubic graphs [8].

There was also a remarkable progress on general Graphic TSP [16–18] leading to the approximation factor  $7/5$ , cf. Sebö and Vygen [20].

The (1,2)-TSP can be viewed as a special case of the Graphic TSP. To see this, we simply augment the subgraph induced by all weight 1 edges in an instance of the (1,2)-TSP by a new vertex  $z$  and add all edges connecting the original vertices with that vertex  $z$ . Thus, the explicit approximation lower bound of  $535/534$  for general (1,2)-TSP is also the inapproximability bound for the general Graphic TSP. It is also known that the factor  $3/2$  of Christofides' algorithm [6] for the general metric TSP is tight for the Graphic TSP on cubic graphs. The best up to now approximation factor for (1,2)-TSP is  $8/7$  [3] (see also [19]).

In this paper, we attack both cubic and subcubic (1,2)-TSP and Graphic TSP, and will use inherent connections between that problems.

#### 5. MAIN RESULTS

We prove the following explicit inapproximability results. The result for Graphic TSP on cubic graphs is the first inapproximability result known for that problem.

**Theorem 5.1.** *The Subcubic (1,2)-TSP is NP-hard to approximate to within any factor less than  $673/672$ .*

**Theorem 5.2.** *The Cubic (1,2)-TSP is NP-hard to approximate to within any factor less than  $1141/1140$ .*

For subcubic and cubic instances of the Graphic TSP, we prove the following.

**Theorem 5.3.** *The Graphic TSP on subcubic graphs is NP-hard to approximate to within any factor less than  $685/684$ .*

**Theorem 5.4.** *The Graphic TSP on cubic graphs is NP-hard to approximate to within any factor less than  $1153/1152$ .*

## 6. TECHNIQUES USED

The method and techniques of the paper use new modular constructions of simulating gadgets and also extend some of the ideas of [14, 15]. The underlying constructions and their correctness arguments are presented in the subsequent sections.

## 7. HYBRID PROBLEM

We start with defining the following Hybrid problem (*cf.* [1], see also and [2]).

**Definition 7.1** (Hybrid problem). Given a system of linear equations mod 2 containing  $n$  variables,  $m_2$  equations with exactly two variables, and  $m_3$  equations with exactly three variables, find an assignment to the variables that satisfies as many equations as possible.

The following result is due to Berman and Karpinski [1].

**Theorem 7.2** ([1]). *For every constant  $\epsilon \in (0, 1/2)$  and  $b \in \{0, 1\}$ , there exist instances of the Hybrid problem  $I_{\mathcal{H}}$  with  $42\nu$  variables,  $60\nu$  equations with exactly two variables, and  $2\nu$  equations of the form  $x \oplus y \oplus z = b$  such that:*

- (i) *Each variable occurs exactly three times.*
- (ii) *It is NP-hard to decide whether there is an assignment to the variables that leaves at most  $\epsilon \cdot \nu$  equations unsatisfied, or else every assignment leaves at least  $(1 - \epsilon)\nu$  equations unsatisfied.*
- (iv) *An assignment to the variables in  $I_{\mathcal{H}}$  can be transformed in polynomial time into an assignment satisfying all  $60\nu$  equations with two variables without decreasing the total number of satisfied equations in  $I_{\mathcal{H}}$ .*

The instances of the Hybrid problem produced in Theorem 7.2 have an even more special structure, which we are going to describe. For this, we are going to introduce the MAX-E3LIN2 problem: given a systems  $I$  of linear equations mod 2 with exactly 3 variables in each equation, find an assignment that maximizes the number of satisfied equations in  $I$ .

For the MAX-E3LIN2 problem, Håstad [12] gave an optimal inapproximability result stated below.

**Theorem 7.3** (Håstad [12]). *For every  $\epsilon \in (0, 1/2)$ , there exists a constant  $B_\epsilon$  and instances of the MAX-E3LIN2 problem with  $2 \cdot \nu$  equations such that:*

- (i) *Each variable in the instance occurs at most  $B_\epsilon$  number of times.*
- (ii) *It is NP-hard to distinguish whether there is an assignment satisfying all but at most  $\epsilon \cdot \nu$  equations, or every assignment leaves at least  $(1 - \epsilon)\nu$  equations unsatisfied.*

In the following, we describe briefly the reduction given in [1] from the MAX-E3LIN2 problem to the Hybrid problem and give the proof of Theorem 7.2. For this, let us first recall some definitions (see also [BK03]).

Let  $G$  be a graph and  $X \subset V(G)$ . We say that  $G$  is a  $d$ -regular amplifier for  $X$  if the following two conditions hold:

- (i) All vertices in  $X$  have degree  $(d-1)$  and all vertices in  $V(G)\setminus X$  have degree  $d$ .
- (ii) For every non-empty subset  $U \subset V(G)$ , we have the condition that

$$|E(U, V(G)\setminus U)| \geq \min\{|U \cap X|, |(V(G)\setminus U) \cap X|\},$$

where  $E(U, V(G)\setminus U) = \{e \in E(G) \mid |U \cap e| = 1\}$ .

We call  $X$  the set of contact vertices and  $V(G)\setminus X$  the set of checker vertices. Amplifier graphs are used for proving hardness of approximation for Constraint Satisfaction problems, in which every variable occurs a bounded number of times. Berman and Karpinski [1] gave a probabilistic argument on the existence of 3-regular amplifiers. In particular, they constructed a very special amplifier graph, which they called wheel amplifier.

A *wheel amplifier*  $\mathcal{W}$  with  $2n$  contact vertices is constructed as follows. We first create a Hamiltonian cycle on  $14n$  vertices with edge set  $C(\mathcal{W})$ . Then, we number the vertices  $1, 2, \dots, 14n$  and select uniformly at random a perfect matching  $M(\mathcal{W})$  on the vertices whose number is not a multiple of 7. The vertices in the matching are our checker vertices and the remaining vertices are our contacts. The set  $M(\mathcal{W}) \cup C(\mathcal{W})$  defines the edge set of  $\mathcal{W}$ . It is not hard to see that the degree requirements are satisfied. Berman and Karpinski [1] gave a probabilistic argument to prove that with high probability the above construction indeed produces a 3-regular amplifier graph.

**Theorem 7.4** (Berman and Karpinski [1]). *With high probability, wheel amplifiers are 3-regular amplifiers.*

Let us proceed and give the proof of Theorem 7.2.

*Proof of Theorem 7.2.* Let  $\epsilon \in (0, 1/2)$  be a constant and  $I$  an instance of the MAX-E3LIN2 problem, in which the number of occurrences of each variable is bounded by  $B_\epsilon$ . For a fixed  $b \in \{0, 1\}$ , we can negate some of the variables such that all equations in the instance  $I$  are of the form  $x \oplus y \oplus z = b$ , where  $x, y, z$  are variables or negated variables.

For a variable  $x_i$  in  $I$ , we denote by  $d_i$  the number of occurrences of  $x_i$  in  $I_1$ . For each  $x_i$ , we create a set of  $7 \cdot d_i = \alpha$  new variables  $Var(i) = \{x_j^i\}_{j=1}^\alpha$ . In addition, we construct a wheel amplifier  $\mathcal{W}_i$  on  $\alpha$  vertices with  $d_i$  contacts. Since  $d_i$  is bounded by a constant, it can be accomplished in constant time. In the remainder, we refer to *contact* and *checker* variables as  $x_l^i \in Var(i)$ , whose corresponding index  $l$  is a contact and checker vertex in  $\mathcal{W}_i$ , respectively.

Let us now define the equations of the new instance  $I_{\mathcal{H}}$  of the Hybrid problem. For each edge  $\{j, k\} \in M(\mathcal{W}_i)$ , we create  $x_j^i \oplus x_k^i = 0$  and refer to equations

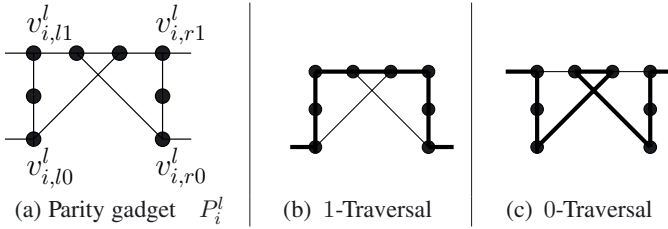

FIGURE 1. 0/1-Traversals of the parity gadget  $P_i^l$ . Traversed edges are displayed by thick lines.

of this form as *matching equations*. On the other hand, for each edge  $\{l, t\}$  in  $C(\mathcal{W}_i)$ , we introduce  $x_l^i \oplus x_t^i = 0$ . Equations of the form  $x_i \oplus x_{i+1} = 0$  with  $i \in \{2, \dots, \alpha - 1\}$  and  $x_1 \oplus x_\alpha = 0$  are called *cycle equations*, whereas  $x_1 \oplus x_2 = 0$  is the cycle border equation. Finally, we replace the  $j$ th occurrence of  $x_i$  in  $I$  by the contact variable  $x_\lambda^i$ , where  $\lambda = 7 \cdot j$ . Accordingly, we have  $2\nu$  equations with three variables in  $I_{\mathcal{H}}$ ,  $60\nu$  equations with two variables and each variable appears in exactly 3 equations.

We call an assignment to  $Var(i)$  as *consistent* if for  $b_i \in \{0, 1\}$ , we have that  $x_j^i = b_i$  for all  $j \in [\alpha]$ . A consistent assignment to the variables of  $I_{\mathcal{H}}$  is an assignment that is consistent for each  $Var(i)$ . By using standard arguments and the amplifier constructed in Theorem 7.4, we are able to transform an assignment to the variables of  $I_{\mathcal{H}}$  into a consistent one without decreasing the number of satisfied equations and the proof of Theorem 7.2 follows.  $\square$

### 8. (1,2)-TSP IN GRAPHS WITH MAXIMUM DEGREE 5

In this section, we describe the reduction constructed in [15] from the Hybrid problem to the (1,2)-TSP. In particular, this construction can be used to prove the following theorem.

**Theorem 8.1** ([15]). *The (1,2)-TSP is NP-hard to approximate to within any factor less than  $535/534$ .*

#### 8.1. THE CONSTRUCTION OF $G_{\mathcal{H}}^{12}$

In the following, we describe briefly the reduction from the Hybrid problem to the (1,2)-TSP and refer for more details to [14, 15].

Let  $I_{\mathcal{H}}$  be an instance of the Hybrid problem with  $n$  wheels,  $60\nu$  equations with two variables and  $2\nu$  equations with three variables. In order to simulate the variables of  $I_{\mathcal{H}}$ , we introduce for each variable  $x_i^l$  the corresponding parity gadget  $P_i^l$  displayed in Figure 1a. If we start in  $v_{i,l,1}^l$  or  $v_{i,l,0}^l$ , there are two ways to traverse this gadget visiting every vertex only once. In the following, we refer to those traversals as 0/1-traversals, which are defined in Figures 1b and 1c.

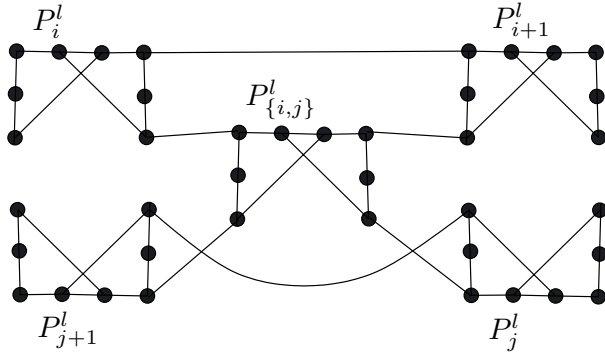

FIGURE 2. Construction simulating the equations  $x_i^l \oplus x_{i+1}^l = 0$ ,  $x_i^l \oplus x_{j+1}^l = 0$  and  $x_j^l \oplus x_{j+1}^l = 0$ .

The idea of the parity gadgets is that any tour in the instance of the (1,2)-TSP can be transformed into a tour, which uses only 0/1-traversals of all parity gadgets that are contained as a subgraph in  $G_{\mathcal{H}}^{1,2}$  without increasing its cost. The 0/1-traversal of the parity gadget defines the value that we assign to the variable associated with the parity gadget.

For each equation, we have a specific way to connect the parity gadgets that are simulating the variables of the underlying equation. Let us start with the construction for matching equations.

**Matching equations:** Given a matching equation  $x_i^l \oplus x_j^l = 0$  in  $I_{\mathcal{H}}$  with  $i < j$  and the cycle equations  $x_i^l \oplus x_{i+1}^l = 0$  and  $x_j^l \oplus x_{j+1}^l = 0$ , we connect the associated parity gadgets  $P_i^l, P_{i+1}^l, P_{i,j}^l, P_j^l$  and  $P_{j+1}^l$  as displayed in Figure 2.

**Equations with three variables:** For equations with three variables  $x \oplus y \oplus z = 0 = b_c^3$  in  $I_{\mathcal{H}}$ , we use the graph  $G_c^{3\oplus}$  displayed in Figure 3. Engebretsen and Karpinski [9] introduced this graph and proved the following statement.

**Lemma 8.2 ([9]).** *There is a simple path from  $s_c$  to  $s_{c+1}$  in Figure 3 containing the vertices  $v_c^1$  and  $v_c^2$  if and only if an even number of parity gadgets is traversed.*

We now explain how we connect the parity gadgets for  $x_i$  and  $x_{i+1}$  with  $G_c^{3\oplus}$ : let us assume that  $x_i \oplus y \oplus z = 0$  and  $x_i \oplus x_{i+1} = 0$  are equations in  $I_{\mathcal{H}}$ . We denote the parity gadgets that appear in  $G_c^{3\oplus}$  as  $P_{(x,i)}, P_y$  and  $P_z$ .

Then, we connect  $P_i^l$  and  $P_{i+1}^l$  with  $P_{(x,i)}$  via edges  $\{v_{i,r0}^l, v_{(x,i),r1}^l\}, \{v_{i+1,l0}^l, v_{(x,i),l1}^l\}$ . Furthermore, we add  $\{v_{i,r1}^l, v_{i+1,l1}^l\}$  to connect  $P_i^l$  and  $P_{i+1}^l$ . If  $x_i$  appears negated in the equation with three variables, we create  $\{v_{i,r1}^l, v_{(x,i),r1}^l\}$  and  $\{v_{i+1,l1}^l, v_{(x,i),l1}^l\}$  and  $\{v_{i,r0}^l, v_{i+1,l0}^l\}$ .

**Cycle border equations:** For each wheel  $\mathcal{W}_l$  with  $l \in [n]$ , we introduce three vertices  $b_l^1, b_l^2$  and  $b_l^3$ , which are connected via  $b_l^1 - b_l^2 - b_l^3$ . Let  $\{x_i^l\}_{i=1}^{\alpha}$  be the

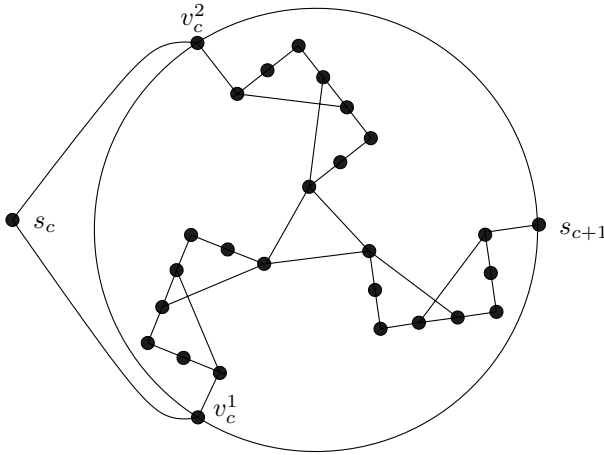

FIGURE 3. Graph  $G_c^{3\oplus}$  simulating  $x \oplus y \oplus z = 0$ .

associated set of variables of  $\mathcal{W}_l$ . Then, we connect  $b_l^3$  with  $v_{l,10}^l$  and  $v_{l,r1}^l$ . In addition, we add  $\{b_{l+1}^1, v_{l,l1}^l\}$  and  $\{b_{l+1}^1, v_{l,r0}^l\}$ .

For the last wheel, we introduce the path  $b_{n+1}^1 - b_{n+1}^2 - s_1$ , where  $s_1$  is the starting vertex of the graph  $G_1^{3\oplus}$  simulating an equation with three variables. The graphs corresponding to equations with three variables are connected via vertices  $s_1, \dots, s_{2\nu+1}$ , where  $s_{2\nu+1} = b_1^1$  is the first vertex of the path  $b_1^1 - b_1^2 - b_1^3$ . This is the whole description of the corresponding graph  $G_{\mathcal{H}}^{12}$ .

### 8.2. ASSIGNMENT TO TOUR

We are going to prove one direction of the reduction and prove the following lemma.

**Lemma 8.3.** *Let  $I_{\mathcal{H}}$  be an instance of the Hybrid problem with  $n$  wheels,  $60\nu$  equations with two variables and  $2\nu$  equations with three variables and  $\phi$  an assignment that leaves  $\delta\nu$  equations in  $I_{\mathcal{H}}$  unsatisfied for a constant  $\delta \in (0, 1)$ . Then, there is a tour in  $G_{\mathcal{H}}^{12}$  with cost at most  $534\nu + 3(n + 1) - 1 + \delta\nu$ .*

*Proof.* According to Theorem 7.2, we may assume that all variables associated to a wheel take the same value under  $\phi$ . Our tour in  $G_{\mathcal{H}}^{12}$  starts in  $b_1^1$  and traverses  $b_1^1 - b_1^2 - b_1^3$ . Then, we use the  $\phi(x_1^1)$ -traversals of the parity gadgets corresponding to the variables of the wheel  $\mathcal{W}_1$  until we enter the vertex  $b_2^1$ . For each wheel, we use the corresponding traversal defined by the assignment. Finally, we get to the vertex  $s_1$ , which belongs to the graph  $G_1^{3\oplus}$ . We refer to this part of the tour as the *inner loop*. In the remaining part of the tour, we are going to traverse the graphs corresponding to equations with three variables. If an odd number of parity gadgets was visited in the inner loop, we can find a Hamiltonian path in  $G_c^{3\oplus}$ . In the other



case, we have to introduce two endpoints. In the *outer loop* of the tour, we visit all gadgets corresponding to equations with three variables. Accordingly, our tour has cost at most  $8 \cdot 60\nu + (3 \cdot 8 + 3) \cdot 2\nu + 3(n + 1) - 1 + \delta\nu$ .  $\square$

8.3. TOUR TO ASSIGNMENT

In the following, we briefly describe the other part of the reduction given in [15].

Let us first introduce the notion of consistent tours. We call a (1,2)-tour  $\pi$  in  $G_{\mathcal{H}}^{12}$  *consistent* if all parity gadgets in  $G_{\mathcal{H}}^{12}$  are visited by  $\pi$  using a 0/1-traversal. In order to ensure that we can restrict ourselves to consistent (1,2)-tours, the following statement can be proved.

**Lemma 8.4** ([15]). *Let  $\pi$  be a tour in  $G_{\mathcal{H}}^{12}$ . For every parity gadget  $P$  in  $G_{\mathcal{H}}^{12}$ , it is possible to convert efficiently  $\pi$  into a tour  $\sigma$  in  $G_{\mathcal{H}}^{12}$ , that uses a 0/1-traversal of  $P$ , without increasing the cost.*

Due to the following lemma, we can construct efficiently an assignment if we are given a consistent tour in  $G_{\mathcal{H}}^{12}$ .

**Lemma 8.5** ([15]). *Let  $\pi$  be a consistent tour in  $G_{\mathcal{H}}^{12}$  with cost  $534\nu + 3(n + 1) - 1 + \delta\nu$  for some constant  $\delta \in (0, 1)$ . Then, it is possible to construct efficiently an assignment that leaves at most  $\delta\nu$  equations in  $I_{\mathcal{H}}$  unsatisfied.*

We are ready to give the proof of Theorem 8.1.

*Proof of Theorem 8.1.* Let  $I$  be an instance of the MAX-E3LIN2 problem with  $n$  variables and  $2\gamma$  equations. For all  $\tau > 0$ , there exists a constant  $k$  such that if we create  $k$  copies of each equation, we get an instance  $I^k$  with  $2\nu = k \cdot 2\gamma$  equations and  $n$  variables with  $3(n + 1) + 1 \leq \nu \cdot \tau$ . From  $I^k$ , we generate an instance  $I_{\mathcal{H}}$  of the Hybrid problem consisting of  $n$  wheels,  $60\nu$  equations with two variables and  $2\nu$  equations with three variables. Finally, we construct the associated instance  $G_{\mathcal{H}}^{12}$  of the (1,2)-TSP.

Given an assignment  $\phi$  to the variables of  $I_{\mathcal{H}}$  leaving  $\delta \cdot \nu$  equations unsatisfied with  $\delta \in (0, 1)$ , according to Lemma 8.3, there is a tour with length at most  $534\nu + 3(n + 1) - 1 + \delta \cdot \nu$ .

On the other hand, if we are given a tour  $\sigma$  in  $G_{\mathcal{H}}^{12}$  with cost  $534\nu + 3(n + 1) - 1 + \delta \cdot \nu$ , it is possible to transform  $\sigma$  in polynomial time into a consistent tour  $\pi$  without increasing the cost by applying Lemma 8.4 to each parity gadget in  $G_{\mathcal{H}}^{12}$ . Moreover, due to Lemma 8.5, we are able to construct efficiently an assignment, which leaves at most  $\delta\nu$  equations in  $I_{\mathcal{H}}$  unsatisfied.

According to Theorem 7.2, we know that for all  $\epsilon > 0$ , it is NP-hard to decide whether there is a tour with cost at most  $534\nu + 3(n + 1) - 1 + \epsilon \cdot \nu \leq 534 \cdot \nu + \epsilon' \nu$  or all tours have cost at least  $534 \cdot \nu + (1 - \epsilon)\nu + 3(n + 1) - 1 \geq 535 \cdot \nu - \epsilon' \cdot \nu$ , for some  $\epsilon'$  which depends only on  $\epsilon$  and  $\tau$ . By appropriate choices for  $\epsilon$  and  $\tau$ , the ratio between these two cases can get arbitrarily close to  $535/534$ .  $\square$

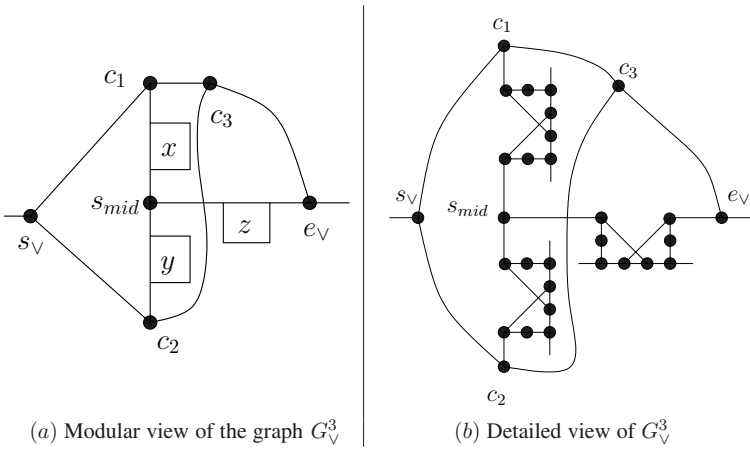

FIGURE 4. The graph  $G_V^3$  corresponding to  $(x \vee y \vee z)$ .

### 9. (1,2)-TSP IN SUBCUBIC GRAPHS

In this section, we are going to define a new outer loop of the construction from the previous section in order to obtain an instance of the (1,2)-TSP in subcubic graphs.

The gadgets simulating equation with three variables in the construction given in [15] contain vertices with degree 5. We are going to replace these gadgets by cubic graphs which we will specify later on. In order to understand the cubic gadgets, we first describe a reduction from the MAX-E3LIN2 problem to the MAX-2in3SAT problem. The reduction is straightforward: Given an equation of the form  $x \oplus y \oplus z = 0$ , we create three clauses  $(x \vee a_1 \vee a_2)$ ,  $(y \vee a_2 \vee a_3)$  and  $(z \vee a_1 \vee a_3)$ . Note that if we are given an assignment to  $x, y$  and  $z$  that satisfies the equation mod 2, then, it is possible to find an assignment to  $a_1, a_2$  and  $a_3$  that satisfies all three corresponding clauses. In the other case, we find assignments to  $a_1, a_2$  and  $a_3$  that make at most two clauses satisfied.

In the next step, we are going to design a gadget that simulates the predicate 2in3SAT. This gadget is displayed in Figure 4a. The boxes can be viewed as modules, which will be replaced with a parity gadget or a graph with similar properties (see Fig. 8). Any graph with less vertices and the properties of a parity gadget will lead to improved inapproximability factors for the corresponding problems. Note that the graph in Figure 4b has degree at most 3.

We are going to prove the following lemma.

**Lemma 9.1.** *There is a Hamiltonian path from  $s_V$  to  $e_V$  in the graph displayed in Figure 4a if and only if 2 edges with modules are traversed.*

*Proof.* There are three possibilities to enter the vertex  $s_{mid}$ . Therefore, a Hamiltonian path in  $G_V^3$  contains (i)  $c_1 - s_{mid} - c_2$ , (ii)  $c_1 - s_{mid} - e_V$  or

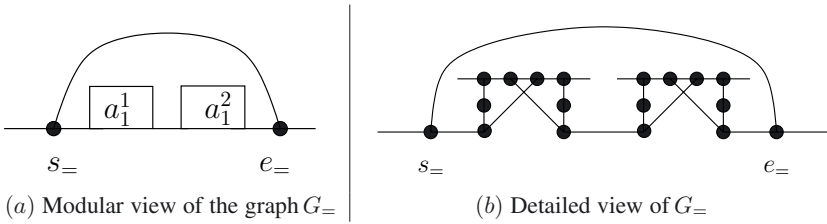

FIGURE 5. Graph  $G_=-$  corresponding to  $a_1^1 \oplus a_1^2 = 0$ .

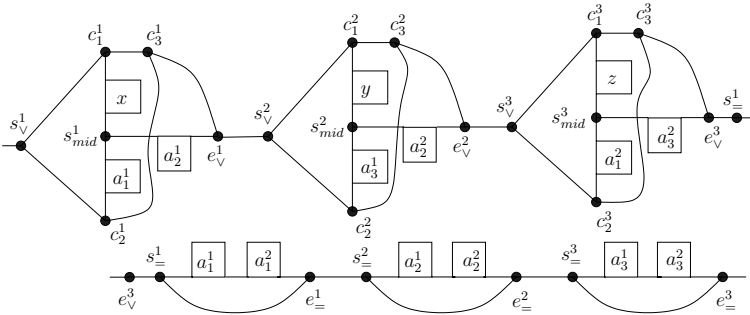

FIGURE 6. Modular view of the construction simulating  $x \oplus y \oplus z = 0$ .

(iii)  $c_2 - s_{mid} - e_v$ . In the case (i), we are forced to use  $\{c_3, e_v\}$  and then, either  $\{s_v, c_1\}$  and  $\{c_3, c_2\}$  or  $\{s_v, c_2\}$  and  $\{c_3, c_1\}$ . In the case (ii), we first note that we cannot use  $\{e_v, c_3\}$ . Due to the degree condition, we have to use  $c_2 - c_3 - c_1$ . The only remaining vertex with degree one is  $c_2$  and has to be connected to  $s_v$ . In case (iii), we may argue similarly to case (ii).  $\square$

As for the next step, we introduce a gadget that simulates  $a_1^1 \oplus a_1^2 = 0$  displayed in Figure 5. We see that in order to get from the vertex  $s_1$  to  $e_1$ , we simply use the edge  $\{s_1, e_1\}$  or the three edges which are connecting the two parity gadgets.

We are ready to describe the construction that simulates the equation  $x \oplus y \oplus z = 0$ : we create three copies of the gadget  $G_v^3$ , denoted by  $G_v^{31}$ ,  $G_v^{32}$  and  $G_v^{33}$ , to simulate  $(x \vee a_1^1 \vee a_2^1)$ ,  $(y \vee a_2^2 \vee a_3^1)$  and  $(z \vee a_1^2 \vee a_3^2)$ . For each  $i \in [3]$ , the vertex set of  $G_v^{3i}$  is defined by  $\{s_v^i, c_1^i, c_2^i, c_3^i, e_v^i, s_{mid}^i\}$ . In order to connect those three copies, we add the edge  $\{e_v^i, s_v^{i+1}\}$  for each  $i \in [2]$ . In the next step, we create three copies of the gadget  $G_=-^3$ , denoted by  $G_=-^1$ ,  $G_=-^2$  and  $G_=-^3$ , to simulate  $a_1^1 \oplus a_1^2 = 0$ ,  $a_2^1 \oplus a_2^2 = 0$  and  $a_3^1 \oplus a_3^2 = 0$ . For each  $i \in [3]$ , the vertex set of  $G_=-^i$  is defined by  $\{s_=-^i, e_=-^i\}$ . Again, we connect those three copies by adding  $\{e_=-^i, s_=-^{i+1}\}$  for each  $i \in [2]$  and we also create  $\{e_v^3, s_=-^1\}$  in order to connect  $G_v^3$  with  $G_=-^1$ . The whole construction is illustrated in Figure 6.

Finally, we connect the graphs that we introduced by parity gadgets as follows: For each graph  $G_=-^i$ , we create two parity gadgets and connect them to the

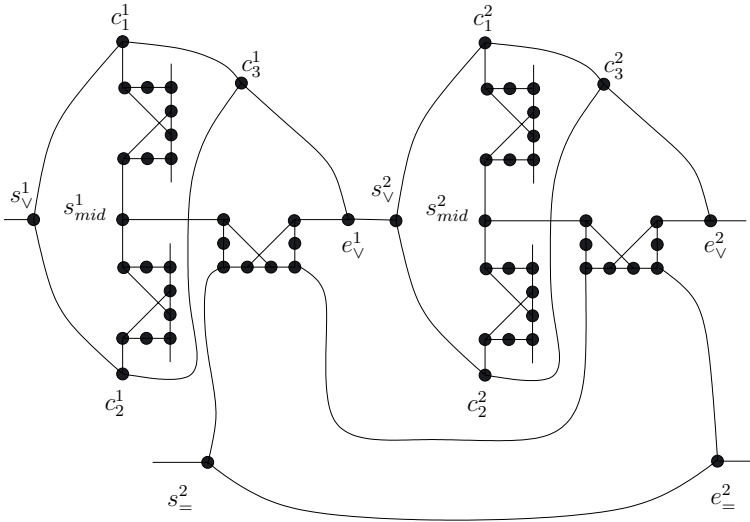

FIGURE 7. Detailed view of the gadget for  $(x \vee a_1^1 \vee a_2^1)$ ,  $(y \vee a_2^2 \vee a_3^1)$  and  $a_2^1 \oplus a_2^2 = 0$ .

graph  $G_{\vee}^{3j}$  corresponding the clause, in which the variable  $a_i^k$  with  $k \in \{1, 2\}$  appear (See Fig. 7 for a detailed view). The parity gadgets, which are associated to the variables  $x, y$  and  $z$ , are attached to  $G_{\vee}^{3j}$  with  $j \in \{1, 2, 3\}$  similarly as in the construction described in Section 8.1 for the graph  $G_c^{3\oplus}$ . Hence, the parity gadget is also connected to the graph which is associated to the wheel  $\mathcal{W}_\alpha$ , where  $\alpha \in \{x, y, z\}$ .

Given an instance  $I_{\mathcal{H}}$  of the Hybrid problem, we refer to the corresponding instance of the (1,2)-TSP in subcubic graphs as  $G_{SC}^{12}$ .

### 9.1. TOUR FROM ASSIGNMENT

We are going now to construct a tour from a given assignment and prove the following lemma.

**Lemma 9.2.** *Let  $I_{\mathcal{H}}$  be an instance of the Hybrid problem with  $n$  wheels,  $60\nu$  equation with two variables,  $2\nu$  equations with three variables and  $\phi$  an assignment that leaves at most  $\delta\nu$  equations unsatisfied. Then, there is a tour in  $G_{SC}^{12}$  with cost at most  $672\nu + 3(n + 1) - 1 + \delta\nu$ .*

*Proof.* Given the assignment  $\phi$ , we define the inner loop of the tour in  $G_{SC}^{12}$  in the same way as in Lemma 8.3. This means that some of the parity gadgets which are connected to gadgets simulating equations with three variables may have been traversed in the inner loop of the tour. In the outer loop of the tour, if the assignment satisfies the underlying equation  $x \oplus y \oplus z = 0$ , then there is a Hamiltonian path traversing all graphs corresponding to  $(x \vee a_1^1 \vee a_2^1)$ ,  $(y \vee a_2^2 \vee a_3^1)$ ,  $(z \vee a_1^1 \vee a_3^2)$ ,

$a_1^1 \oplus a_1^2 = 0$ ,  $a_2^1 \oplus a_2^2 = 0$  and  $a_3^1 \oplus a_3^2 = 0$ . For each satisfied equation with three variables, we associate the cost  $3(6 + 3 \cdot 8 + 2)$ . If the underlying equation is not satisfied, we have to introduce two endpoints. Thus, we associate the cost  $3(6 + 3 \cdot 8 + 2) + 1$ . Summing up, we obtain a tour in  $G_{SC}^{12}$  with cost at most  $8 \cdot 60\nu + 3 \cdot (6 + 3 \cdot 8 + 2) \cdot 2\nu + 3(n + 1) - 1 + \delta\nu = 672\nu + 3(n + 1) - 1 + \delta\nu$ .  $\square$

9.2. ASSIGNMENT FROM TOUR

Given a tour in  $G_{SC}^{12}$ , we are going to construct an assignment to the variables of the corresponding instance  $I_{\mathcal{H}}$  of the Hybrid problem and prove the following lemma.

**Lemma 9.3.** *Let  $I_{\mathcal{H}}$  be an instance of the Hybrid problem with  $n$  wheels,  $60\nu$  equations with two variables,  $2\nu$  equations with three variables and  $\pi$  a tour in  $G_{SC}^{12}$  with cost  $672\nu + 3(n + 1) - 1 + \delta\nu$ . Then, it is possible to construct efficiently an assignment that leaves at most  $\delta\nu$  equations in  $I_{\mathcal{H}}$  unsatisfied.*

*Proof.* In the first step, we convert the underlying tour in  $G_{SC}^{12}$  into a consistent one without increasing its cost. This is done by applying Lemma 8.4 to each parity gadget in  $G_{SC}^{12}$ . In the second step, we use the same 0/1-traversals of the parity gadgets in the inner loop of the tour which enables us to construct a tour in the corresponding instance  $G_{\mathcal{H}}^{12}$  with cost at most

$$672\nu + 3(n + 1) - 1 + \delta\nu - 3 \cdot (6 + 3 \cdot 8 + 2) \cdot 2\nu + (3 \cdot 8 + 3) \cdot 2\nu = 534\nu + 3(n + 1) - 1 + \delta\nu.$$

Finally, we apply Lemma 8.5 and compute efficiently an assignment that leaves at most  $\delta\nu$  equations in  $I_{\mathcal{H}}$  unsatisfied.  $\square$

We are ready to give the proof of Theorem 5.1.

*Proof of Theorem 5.1.* Given  $I_{\mathcal{H}}$  an instance of the Hybrid problem consisting of  $n$  wheels,  $60\nu$  equations with two variables and  $2\nu$  equations with three variables, we construct in polynomial time the associated instance  $G_{SC}^{12}$  of the (1,2)-TSP.

Given an assignment  $\phi$  to the variables of  $I_{\mathcal{H}}$  leaving  $\delta \cdot \nu$  equations unsatisfied with  $\delta \in (0, 1)$ , then, according to Lemma 9.2, it is possible to find a tour with cost at most  $672\nu + 3(n + 1) - 1 + \delta \cdot \nu$ .

On the other hand, if we are given a tour  $\sigma$  in  $G_{SC}^{12}$  with cost  $672\nu + 3(n + 1) - 1 + \delta \cdot \nu$ , due to Lemma 9.3, we are able to construct efficiently an assignment to the variables of  $I_{\mathcal{H}}$ , which leaves at most  $\delta\nu$  equations in  $I_{\mathcal{H}}$  unsatisfied.

Similarly to the proof of Theorem 8.1, for a constant  $\tau > 0$ , we may assume that  $(3n + 4)/\nu \leq \tau$  holds. According to Theorem 7.2, we know that for all  $\epsilon > 0$ , it is NP-hard to decide whether there is a tour with cost at most  $672\nu + 3(n + 1) - 1 + \epsilon \cdot \nu \leq 672 \cdot \nu + \epsilon' \nu$  or all tours have cost at least  $672 \cdot \nu + (1 - \epsilon)\nu + 3(n + 1) - 1 \geq 673 \cdot \nu - \epsilon' \cdot \nu$ , for some  $\epsilon'$  that depends only on  $\epsilon$  and  $\tau$ . By appropriate choices for  $\epsilon$  and  $\tau$ , the ratio between these two cases can get arbitrarily close to  $673/672$ .  $\square$

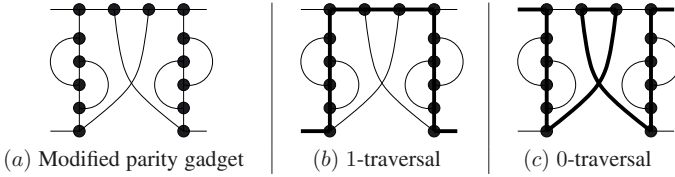

FIGURE 8. 0/1-Traversals of a modified parity gadget. The traversed edges are pictured by thick lines.

### 10. (1,2)-TSP IN CUBIC GRAPHS

This section is devoted to the proof of Theorem 5.2.

#### 10.1. THE CONSTRUCTION OF THE GRAPH $G_{CU}^{12}$

Given an instance  $I_{\mathcal{H}}$  of the Hybrid problem with  $n$  wheels,  $60\nu$  equations with two variables and  $2\nu$  equations with three variables, we construct the corresponding graph  $G_{SC}^{12}$ . In order to convert the instance  $G_{SC}^{12}$  of the (1,2)-TSP in subcubic graphs into an instance  $G_{CU}^{12}$  of the (1,2)-TSP in cubic graphs, we replace all vertices with degree exactly two by a path in which all vertices will have degree exactly three. Let us describe this in detail: Let  $w$  be a vertex with degree two in  $G_{SC}^{12}$ , which is connected to  $x$  and  $y$ . Replace  $w$  with the path  $p_w = v_w^1 - v_w^2 - v_w^3 - v_w^4$ . In addition, we add edges  $\{v_w^1, v_w^3\}$ ,  $\{v_w^2, v_w^4\}$ ,  $\{x, v_w^1\}$  and  $\{y, v_w^4\}$ . By applying this modification to each vertex of degree exactly two, we create a cubic graph and refer to it as  $G_{CU}^{12}$ .

A modified parity gadget is displayed in Figure 8a. The corresponding traversals are defined in Figures 8b and 8c.

The following lemma enables us to construct a tour in  $G_{CU}^{12}$  given an assignment  $\phi$  to the variables of the corresponding instance  $I_{\mathcal{H}}$  of the Hybrid problem with a certain cost that depends on the number on unsatisfied equations in  $I_{\mathcal{H}}$  by  $\phi$ .

**Lemma 10.1.** *Let  $I_{\mathcal{H}}$  be an instance of the Hybrid problem with  $n$  wheels,  $60\nu$  equation with two variables,  $2\nu$  equations with three variables and  $\phi$  an assignment that leaves  $\delta \cdot \nu$  equations unsatisfied for some  $\delta \in (0, 1)$ . Then, it is possible to construct efficiently a tour in  $G_{CU}^{12}$  with cost at most  $1140\nu + 6(n + 1) - 1 + \delta \cdot \nu$ .*

*Proof.* Basically, we use the same tour as constructed in Lemma 9.2 for the graph  $G_{SC}^{12}$  with the difference that instead of traversing a vertex  $w$  of degree exactly two in  $G_{SC}^{12}$ , we have to use the path  $v_w^1 - v_w^2 - v_w^3 - v_w^4$  consisting of 3 more vertices. Thus, if we have given a tour  $\sigma$  in  $G_{SC}^{12}$ , that was constructed according to Lemma 9.2, we have to add  $6 \cdot 60\nu$  (for each equation with two variables),  $9 \cdot 6 \cdot 2\nu$  (for each equation with three variables), and  $3(n + 1)$  (for each wheel) to the cost of  $\sigma$  and obtain a tour in  $G_{CU}^{12}$  with cost at most

$$672\nu + 3(n + 1) - 1 + \delta \cdot \nu + (6 \cdot 60\nu) + 9 \cdot 6 \cdot 2\nu + 3(n + 1) = 1140\nu + 6(n + 1) - 1 + \delta \cdot \nu$$

and the proof of Lemma 10.1 follows. □

10.2. TOUR TO ASSIGNMENT

We are going to prove the other direction of the reduction and give the proof of the following lemma.

**Lemma 10.2.** *Let  $I_{\mathcal{H}}$  be an instance of the Hybrid problem with  $n$  wheels,  $60\nu$  equation with two variables,  $2\nu$  equations with three variables and  $\pi$  a tour in  $G_{CU}^{12}$  with cost  $1140\nu + 6(n + 1) - 1 + \delta \cdot \nu$ . Then, it is possible to construct efficiently an assignment that leaves at most  $\delta \cdot \nu$  equations in  $I_{\mathcal{H}}$  unsatisfied.*

*Proof.* Let  $\pi$  be a tour in  $G_{CU}^{12}$  with cost  $1140\nu + 6(n + 1) - 1 + \delta \cdot \nu$ . We are going to show that we can convert efficiently  $\pi$  into a tour  $\pi'$  in  $G_{SC}^{12}$  with cost  $672\nu + 3(n + 1) - 1 + \delta \cdot \nu$ . For this, we consider the path  $x - v_c^1 - v_c^2 - v_c^3 - v_c^4 - y$  in  $G_{CU}^{12}$ , where  $p_c = v_c^1 - v_c^2 - v_c^3 - v_c^4$  corresponds to the vertex  $c$  of degree exactly two in the instance  $G_{SC}^{12}$ . As we want to contract the path  $p_c$  into one vertex, we will ensure that the (1,2)-tour is using either the path  $v_c^1 - v_c^2 - v_c^3 - v_c^4$  or  $v_c^1 - v_c^3 - v_c^2 - v_c^4$ . Let us assume that either  $v_c^2$  or  $v_c^3$  is an endpoint, say  $v_c^2$ . Clearly, it implies that there is another endpoint in  $\{v_c^1, v_c^3, v_c^4\}$  or  $v_c^2$  is a double endpoint. We delete all edges of weight 1 that the tour is using and are incident on  $v_c^2$  and  $v_c^3$ . Then, we add  $\{v_c^1, v_c^2\}$ ,  $\{v_c^2, v_c^3\}$  and  $\{v_c^3, v_c^4\}$  to connect  $v_c^4$  and  $v_c^1$  by edges of weight 1. Note that this transformation decreased the total number of endpoints and the cost of the (1,2)-tour. By applying this transformation successfully to each such path  $p_c$ , we obtain a tour which is using the complete path that corresponds to a vertex of degree 2 in the instance  $G_{SC}^{12}$  without increasing the cost of the tour. By contracting each path  $p_c$  into the vertex  $c$ , it yields a (1,2)-tour in  $G_{SC}^{12}$  with cost at most  $672\nu + 3(n + 1) + 1 + \delta \cdot \nu$ . Finally, we apply Lemma 9.3 and obtain an assignment that leaves at most  $\delta \cdot \nu$  equations in  $I_{\mathcal{H}}$  unsatisfied.  $\square$

Analogously to the proof of Theorem 5.1, we combine Lemma 10.1 with Lemma 10.2 and obtain Theorem 5.2.

11. GRAPHIC TSP IN SUBCUBIC AND CUBIC GRAPHS

In this section, we are going to give the proof of Theorems 5.3 and 5.4.

11.1. THE CONSTRUCTION

Let  $I_{\mathcal{H}}$  be an instance of the Hybrid problem. We first construct the corresponding instances  $G_{CU}^{12}$  and  $G_{SC}^{12}$  of the (1,2)-TSP in cubic and subcubic graphs, respectively. Each gadget  $G_{=}$  in  $G_{SC}^{12}$  is replaced by the graph  $G_{=}^{gr}$  displayed in Figure 9. We refer to this construction as the graph  $G_{SC}^{gr}$ . In order to obtain an instance of the Graphic TSP on cubic graphs, we use the modified parity gadgets in  $G_{=}^{gr}$  and denote this instance as  $G_{CU}^{gr}$ .

Let us prove one direction of the reductions.

**Lemma 11.1.** *Let  $I_{\mathcal{H}}$  be an instance of the Hybrid problem with  $n$  wheels,  $60\nu$  equation with two variables,  $2\nu$  equations with three variables and  $\phi$  an assignment that leaves at most  $\delta\nu$  equations unsatisfied. Then, there is a tour in  $G_{SC}^{gr}$  and in*

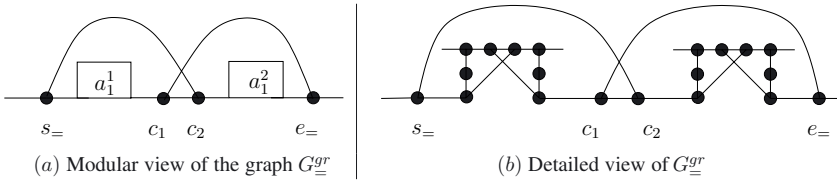

FIGURE 9. Graph  $G_{SC}^{gr}$  corresponding to  $a_1^1 \oplus a_1^2 = 0$ .

$G_{CU}^{gr}$  with cost at most  $684\nu + 3(n + 1) - 1 + \delta\nu$  and  $1152\nu + 6(n + 1) - 1 + \delta\nu$ , respectively.

*Proof.* Let us start with the description of the tour in  $G_{SC}^{gr}$ . As for the inner loop, we use the same tour as in Lemma 9.2. Note that we traversed only edges with weight 1 in the inner loop of the tour in  $G_{SC}^{12}$ . In the outer loop, we cannot use the same shortcuts as in the (1,2)-TSP, since in some cases the weight of an edge can be greater than 2. To ensure that the cost traversing a gadget corresponding to an equation with three variables increases only by one if the equation is unsatisfied by the assignment, we will use the following trick: Consider an equation of the form  $x \oplus y \oplus z = 0$  that is simulated by  $(x \vee a_1^1 \vee a_1^2)$ ,  $(y \vee a_2^2 \vee a_3^1)$ ,  $(z \vee a_1^1 \vee a_3^2)$ ,  $a_1^1 \oplus a_2^2 = 0$ ,  $a_1^2 \oplus a_2^2 = 0$  and  $a_3^1 \oplus a_3^2 = 0$ . If we have an assignment that satisfies  $x \oplus y \oplus z = 0$ , then there is also an assignment that satisfies all 6 associated predicates. Furthermore, we see that in the other case, we can find an assignment that satisfies all predicates except exactly one equation with two variables.

In particular, it implies for a tour traversing the gadget  $G_{SC}^{gr}$  simulating  $a_1^1 \oplus a_2^2 = 0$  that if  $(a_1^1 + a_2^2 = 0)$  and  $(a_1^1 + a_2^2 = 2)$  holds, we use  $s_- - c_2 - c_1 - e_-$  and  $s_- - c_2 - c_1 - e_-$ , respectively. On the other hand, assuming  $(a_1^1 + a_2^2 = 1)$ , we traverse either  $s_- - c_1 - c_2 - c_1 - e_-$  or  $s_- - c_2 - c_1 - c_2 - e_-$ . Thus, we use the edge  $\{c_1, c_2\}$  twice increasing the cost only by 1.

Summarizing, given an assignment leaving  $\delta\nu$  equations unsatisfied, we find a tour in  $G_{SC}^{12}$  with cost at most  $672\nu + 3(n + 1) - 1 + \delta\nu$  and a tour in  $G_{SC}^{gr}$  with cost at most  $684\nu + 3(n + 1) - 1 + \delta\nu$ , since we have to take into account the small detour and add  $3 \cdot 2 \cdot 2\nu$  to the cost.

Under the same conditions, we find a tour in  $G_{CU}^{12}$  with cost at most  $1140\nu + 6(n+1) - 1 + \delta\nu$  and a tour in  $G_{CU}^{gr}$  with cost at most  $1152\nu + 6(n+1) - 1 + \delta\nu$ .  $\square$

### 11.2. TOUR TO ASSIGNMENT

We now give the other direction of the reductions and prove the following lemma.

**Lemma 11.2.** *Let  $I_{\mathcal{H}}$  be an instance of the Hybrid problem with  $n$  wheels,  $60\nu$  equation with two variables,  $2\nu$  equations with three variables,  $\pi$  a tour in  $G_{SC}^{gr}$  with cost  $684\nu + 3(n+1) - 1 + \delta\nu$  and  $\sigma$  a tour in  $G_{CU}^{gr}$  with cost  $1152\nu + 6(n+1) - 1 + \delta\nu$ . By using either  $\pi$  or  $\sigma$ , it is possible to construct efficiently an assignment that leaves at most  $\delta\nu$  equations in  $I_{\mathcal{H}}$  unsatisfied.*



TABLE 1. Inapproximability bounds for the instances of (1,2)-TSP and Graphic TSP.

Restriction	(1,2)-TSP	Graphical TSP
Unrestricted	535/534	535/534
Subcubic	673/672	685/684
Cubic	1141/1140	1153/1152

*Proof.* Let us consider a tour  $\pi$  in  $G_{SC}^{gr}$  with cost  $684\nu + 3(n + 1) - 1 + \delta\nu$ . We interpret  $\pi$  as a (1,2)-tour in  $G_{SC}^{gr}$  with cost at most  $684\nu + 3(n + 1) - 1 + \delta\nu$ . In the first step, we convert the underlying tour in  $G_{SC}^{gr}$  into a consistent one without increasing its cost by applying Lemma 8.4 to each parity gadget in  $G_{SC}^{gr}$ . In the second step, we use the same 0/1-traversals of the parity gadgets in the inner loop which enables us to construct a tour in the corresponding instance  $G_{SC}^{r12}$  with cost at most  $672\nu + 3(n + 1) - 1 + \delta\nu$ . Finally, we apply Lemma 9.3 and construct an assignment leaving at most  $\delta\nu$  equations in  $I_{\mathcal{H}}$  unsatisfied.

Analogously, if we have given a tour in  $G_{SC}^{gr}$  with cost  $1152\nu + 6(n + 1) - 1 + \delta\nu$ , we convert it into a (1,2)-tour without increasing its cost. By applying the contractions defined in Lemma 10.2, we obtain a (1,2)-tour in  $G_{SC}^{gr}$  with cost at most  $684\nu + 3(n + 1) - 1 + \delta\nu$ , for which we already know how to construct an assignment with the desired properties.  $\square$

By combining Lemmas 11.1 and 11.2, we obtain immediately Theorems 5.3 and 5.4.

## 12. SUMMARY OF THE INAPPROXIMABILITY RESULTS

As mentioned before the explicit inapproximability bound of 535/534 [14, 15] for the (1,2)-TSP carries through to the Graphic TSP. We summarize here (Tab. 1) the results of the paper.

## 13. CONCLUSIONS AND FURTHER RESEARCH

We provided new explicit inapproximability bounds for cubic and subcubic instances of (1,2)-TSP and Graphic TSP. The important question is to improve the explicit inapproximability bounds on those instances significantly. A bottleneck in our constructions, especially for the cubic case, are the parity gadgets. Using the modularity of the constructions, any improvement of the costs of the parity gadgets will lead to improved inapproximability bounds for the corresponding problems.

The current best upper approximation bound for general cubic instances of Graphic TSP is  $4/3$  (cf. [4]). For the special case of 2-connected cubic graphs, the bound was recently improved to  $(4/3 - 1/61236)$  [8]. How about further improving those bounds? How about improving the general upper bound of  $8/7$  [3] for cubic instances of the (1,2)-TSP?

*Acknowledgements.* We thank Leen Stougie and Ola Svensson for a number of interesting discussions.

## REFERENCES

- [1] P. Berman and M. Karpinski, On some tighter inapproximability results, in *Proc. of 26th ICALP, LNCS 1644* (1999) 200–209.
- [2] P. Berman and M. Karpinski, *Improved Approximation lower bounds on small occurrence optimization*, ECCO TR03-008 (2003).
- [3] P. Berman and M. Karpinski, 8/7-approximation algorithm for (1,2)-TSP, in *Proc. of 17th SODA* (2006) 641–648.
- [4] S. Boyd, R. Sitters, S. van der Ster and L. Stougie, TSP on cubic and subcubic graphs, in *Proc. of 15th IPCO. Lect. Notes Comput. Sci. 6655* (2011) 65–77.
- [5] S. Boyd, R. Sitters, S. van der Ster and L. Stougie, *TSP on cubic and subcubic graphs. Math. Program* (2011) 227–245.
- [6] N. Christofides, *Worst-case analysis of a new heuristic for the traveling salesman problem*, Technical Report CS-93-13. Carnegie Mellon University, Pittsburgh (1976).
- [7] B. Csaba, M. Karpinski and P. Krysta, Approximability of dense and sparse instances of minimum 2-connectivity, TSP and path problems, in *Proc. of 13th ACM-SIAM SODA* (2002) 74–83.
- [8] J. Correa, O. Larré and J. Soto, TSP tours in cubic graphs: Beyond 4/3, in *Proc. of 20th ESA. Lect. Notes Comput. Sci. 7501* (2012) 790–801.
- [9] L. Engebretsen and M. Karpinski, TSP with bounded metrics. *J. Comput. Syst. Sci.* **72** (2006) 509–546.
- [10] D. Gamarnik, M. Lewenstein and M. Sviridenko, An improved upper bound for the TSP in cubic 3-edge-connected graphs. *Oper. Res. Lett.* **33** (2005) 467–474.
- [11] M. Garey, D. Johnson and R. Tarjan, The planar hamiltonian circuit problem is NP-complete. *SIAM J. Comput.* **5** (1976) 704–714.
- [12] J. Håstad, Some optimal inapproximability results. *J. ACM* **48** (2001) 798–859.
- [13] M. Karpinski, M. Lampis and R. Schmied, New inapproximability bounds for TSP, in *Proc. of 24th ISAAC. Lect. Notes Comput. Sci. 8283* (2013) 568–578.
- [14] M. Karpinski and R. Schmied, On approximation lower bounds for TSP with bounded metrics. *Electron Colloq. Comput. Complexity* **19** (2012).
- [15] M. Karpinski and R. Schmied, On improved inapproximability results for the shortest superstring and related problems, in *Proc. of 19th CATS CRPIT 141* (2013) 27–36.
- [16] T. Mömke and O. Svensson, Approximating graphic TSP by matchings, in *Proc. of IEEE 52nd FOCS* (2011) 560–569.
- [17] M. Mucha, 13/9-Approximation for graphic TSP, in *Proc. of STACS, Vol. 14 of LIPIcs. Schloss Dagstuhl-Leibniz-Zentrum für Informatik* (2012) 30–41.
- [18] S. Oveis Gharan, A. Saberi and M. Singh, A Randomized Rounding Approach to the Traveling Salesman Problem, in *Proc. of IEEE 52nd FOCS* (2011) 550–559.
- [19] C. Papadimitriou and M. Yannakakis, The traveling salesman problem with distances one and two. *Math. Oper. Res.* **18** (1993) 1–11.
- [20] A. Sebö and J. Vygen, Shorter tours by nicer ears. *Combinatorica* **34** (2014) 597–629.